

# Keyboard Trays

## 8250 Pencil Drawer Slide

**PENCIL DRAWER Slide**  
Adjustable Height  
18" & 22" Lengths

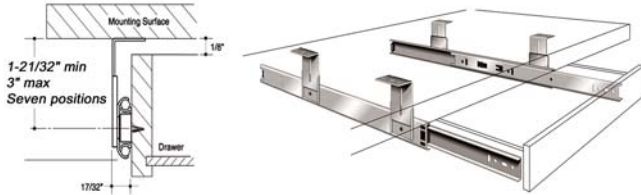

75# capacity 10/Box

ORDER #	LENGTH	ADJUSTABLE HEIGHT	FINISH
<a href="#">150-5353</a>	16"	2-11/32" to 3-11/16"	Anochrome
<a href="#">150-0958</a>	18"	2-11/32" to 3-11/16"	Anochrome
<a href="#">150-5361</a>	20"	2-11/32" to 3-11/16"	Anochrome
<a href="#">150-0875</a>	22"	2-11/32" to 3-11/16"	Anochrome

## 8200 Pencil Drawer Slide

**PENCIL DRAWER Slide**  
75 lb. Capacity  
2-9/16" Overall drop Height

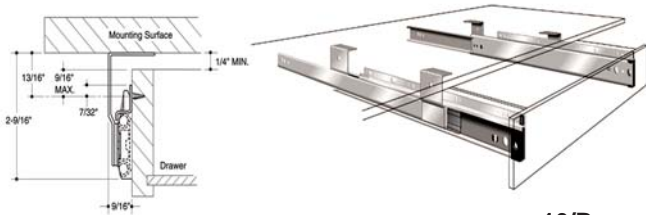

75# capacity 10/Box

ORDER #	MANUF. #	LENGTH	FINISH
<a href="#">150-8654</a>	8200 14	14"	Anochrome
<a href="#">150-8662</a>	8200 16	16"	Anochrome
<a href="#">150-8670</a>	8200 18	18"	Anochrome
<a href="#">150-8688</a>	8200 20	20"	Anochrome
<a href="#">150-8613</a>	8200 22	22"	Anochrome
<a href="#">150-8282</a>	8200 22	24"	Anochrome

## 8150 Keyboard Drawer Slide



8150 Draw Slide

ORDER #	LENGTH	ADJUSTABLE HEIGHT	FINISH
<a href="#">150-1592</a>	14"	2-11/32" to 3-11/16"	Black
<a href="#">150-5379</a>	16"	2-11/32" to 3-11/16"	Black

## 5710 with Mouse Tray



75# CAPACITY



- Complete keyboard tray unit
- Adjustable-seven positions brackets from 2-11/32" to 4-1/4"
- Slide is **ebony black**, keyboard and mouse tray is black steel, wrist rest is black PVC
- Precision steel ball bearing slide assembly
- Integral, adjustable wrist rest. Adjustable drop height. Friction latch in open position
- Mouse tray opens to either left or right
- Guides are not removable

ORDER #	LENGTH	WIDTH	ADJUSTABLE HEIGHT
<a href="#">150-0230</a>	18"	24"	2-11/32" min. to 4-1/4" max.

## 5700 without Mouse Tray

75# CAPACITY

Black finish



ORDER #	LENGTH	WIDTH	ADJUSTABLE HEIGHT
<a href="#">150-0222</a>	18"	24"	2-11/32" min. to 3-11/16" max.

H

# Keyboard Trays

## PENCIL DRAWER

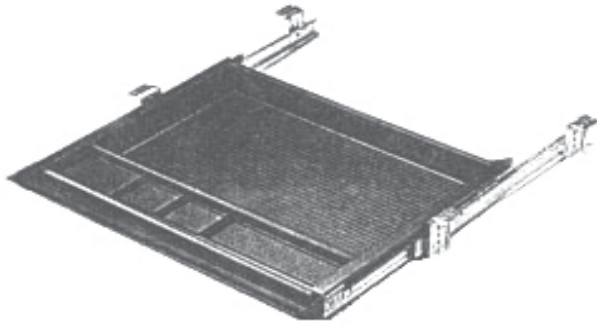

- No Front Required
- With ball bearing metal slides
- Brackets included
- Tray dimensions: 20-7/8" W x 18-1/2" D x 1-57/64" H
- Black tray/black slides

ORDER #	MANUF. #	DEPTH	WIDTH	HEIGHT
824-4378	89710	18-1/2"	20-7/8"	2"

## Prime™ EZ Spec Keyboard



- VL adjustable keyboard mechanism and clamping platform w/ 18" allante wrist rest
- 6" of standard height adjustment
- 18" track length (13" of in/out adjustment)
- EZ-Glide slide system with 360° Swivel
- Cable management system
- All metal construction
- Black wrinkle powder coat finish

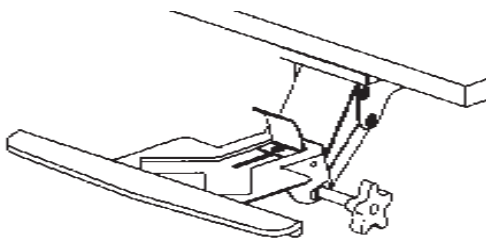

ORDER #	MANUF. #	FINISH
150-8530	PRM-1	Black

## ECONOMY KEYBOARD TRAY

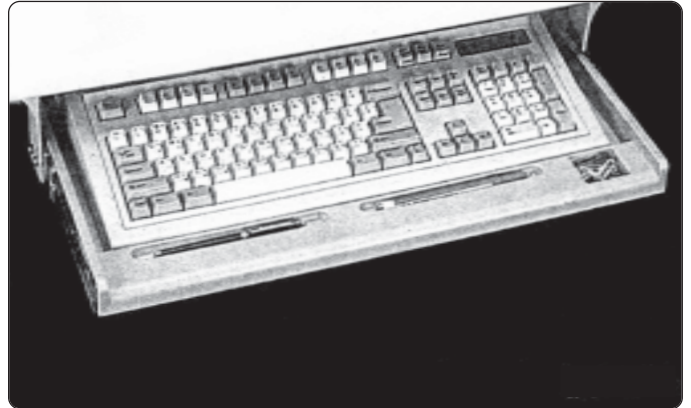

- With ball bearing metal slides
- Brackets included
- Light Grey tray/Zinc slides

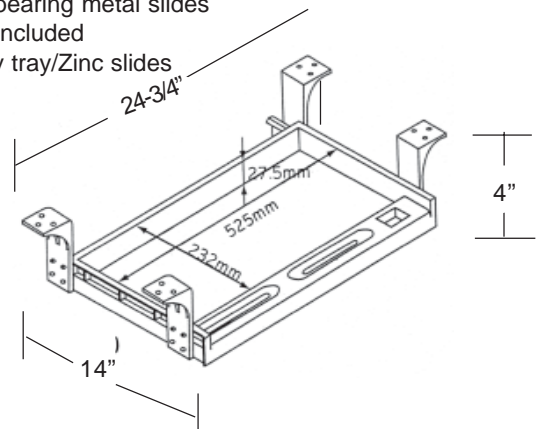

ORDER #	DEPTH	WIDTH	HEIGHT	FINISH
824-0194	14"	24-3/4"	4"	Light Grey

## KEYBOARD AND MOUSE BOARD

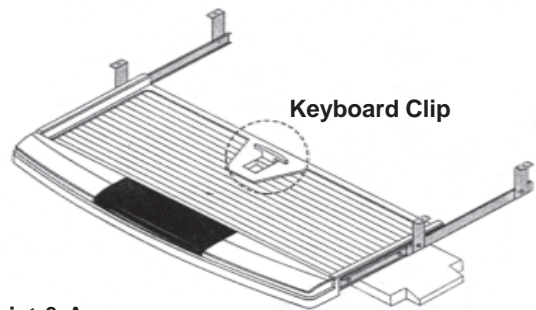

Wrist & Accessory Compartment

ORDER #	DEPTH	WIDTH	HEIGHT	FINISH
824-0202	23"	11-3/4"	3"	Black

H

## Keyboard Trays

### Key-1 Keynetix EZ Spec

#### Keyboard System

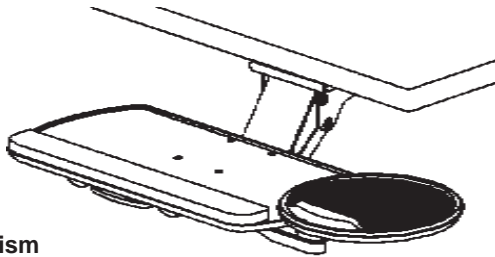

#### Key-1 Mechanism

- Keynetix spring assist adjustable keyboard mechanism
- One touch control for both height & tilt adjustment, 360° swivel
- 6" (standard) or 9-3/4" (extended) of height & tilt adjust
- Comfort shield is a smooth, snag-free surface preventing interference with knees or clothing
- Tilting & swiveling mouse platform option

#### Mouse Platform

Mouse swivel is above the keyboard for a preferred or stored position. Mouse area modularity allows right or left mousing

- Gel wrist rest allows left or right hand mousing
- Tilting & swiveling mouse platform w/ 6-1/2" gel wrist rest for comfort plus series keyboard platform
- Requires no knobs or secondary adjustments

ORDER #	MANUF. #	FINISH
150-8514	KEY-1	Black

### Key-5 Keynetix EZ Spec Keyboard System

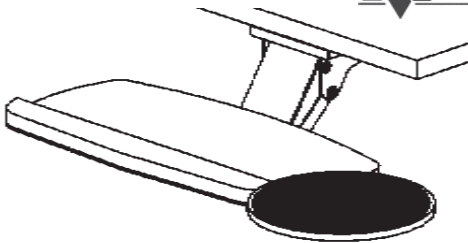

#### Key-5 Mechanism

- Keynetix spring assist adjustable keyboard mechanism
- One touch control for both height & tilt adjustment, 360° swivel
- 6" (standard) or 9-3/4" (extended) of height & tilt adjust

#### Keyboard Platform

Injection molded construction with non-skid surface pads

- One-piece keyboard platform (18"W x 10"D)
- Slim-profile keyboard platform w/ 18" gel wrist rest

#### Mouse Platform

Mouse swivel is above the keyboard for a preferred or stored position. Mouse area modularity allows right or left mousing

ORDER #	MANUF. #	FINISH
150-8522	KEY-5	Black

### Tower Stand CPU Holder



- Stores CPU vertically beneath surface to protect against contaminants & saves valuable workspace
- Adjusts to support most CPU sizes (13-1/2" to 24" H, 3-1/4" to 8 1/2" W, any Depth)
- No tools needed to adjust height or width range
- Securely "clamps" the CPU in position
- 50 lb. weight capacity
- All metal construction
- Finish: Black wrinkle powder coat

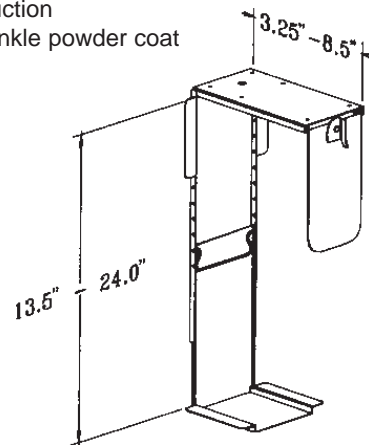

ORDER #	MANUF. #	FINISH
150-8548	CPU-1	Black

### Letter Size Followers



- When mounted plate is 7-5/8" from track surface x 10-3/4" wide
- Track is 26" long, may be recessed in 2-1/4" x 1/4" slot (when 476 follower is used)
- Anochrome finish. Sold in set (track and card follower)

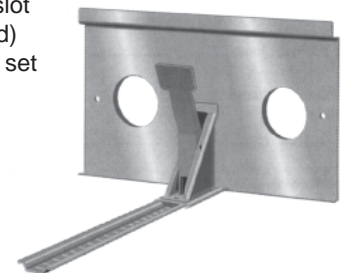

10/Box

ORDER #	MANUF. #	DESCRIPTION
150-1030	476T	Track
150-1121	476F	Follower

# File Rails

## Aluminum File Rails

1/8" Thick

- Aluminum alloy
- Rectangular shape

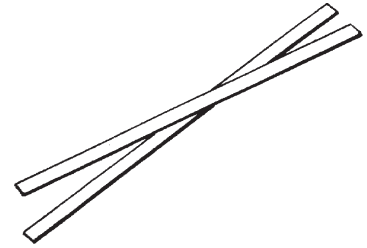

ORDER #	MANUF. #	SIZE	DESCRIPTION
<a href="#">876-0548</a>	61012050-12	1/8" x 1/2" x 144"	Aluminum P-Rail
<a href="#">844-0091</a>	61012075-12	1/8" x 3/4" x 144"	Aluminum P-Rail
<a href="#">844-0141</a>	610120100-12	1/8" x 1" x 144"	Aluminum P-Rail

H

## Plastic File Rails

- Cut to fit plastic hanging file rail
- Designed to fit over 1/2" drawer material
- 8' length

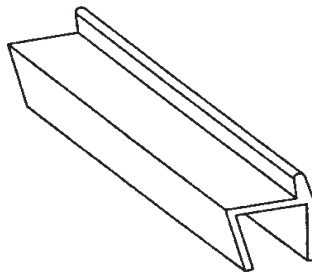

ORDER #	MANUF. #	COLOR
<a href="#">842-0036</a>	CPF312501	White
<a href="#">842-0044</a>	CPF32500	Black

## METAFILE Hanging File Folder System



- METAFILE is a comprehensive system for hanging file folders
- Rail supports attach to the drawer front and back which hold the steel rails
- Cover caps snap over the brackets and glide profiles cover the rails for smooth movement of the folders
- For lateral files use the lateral brackets to connect cross rails
- "Cream" nylon color components

### Steel File Bar

3mm x 13mm x 1100mm (43.3")

#### METAFILE Components

ITEM	ORDER #	FINISH	DESCRIPTION
1 & 7	<a href="#">812-5742</a>	Zinc	1100mm steel hanging rail
2	<a href="#">812-5767</a>	Natural	Rail support brackets
3	<a href="#">812-5775</a>	White	Rail support covers
4 & 8	<a href="#">812-5759</a>	White	1100mm rail cover
5	—	Nickel	Wood screws 6x3/4
6	<a href="#">812-5783</a>	Cream	Lateral bracket
6	<a href="#">812-9868</a>	White	Lateral bracket

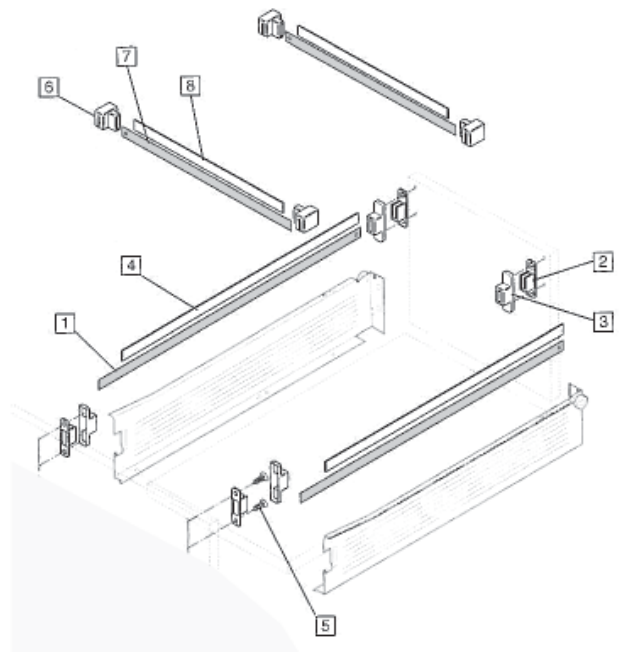

# File Rail Clips

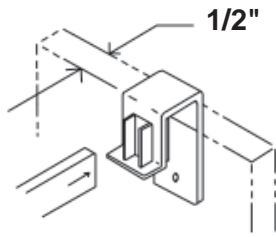

**KHFB-500**

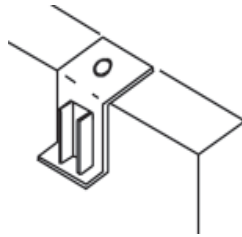

**TOP MOUNT**

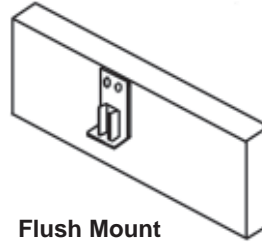

**Flush Mount**

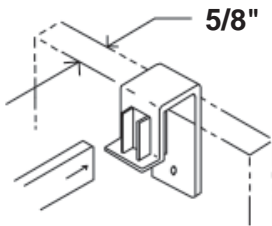

**KHFB-???**

**CAPTIVE MOUNT**

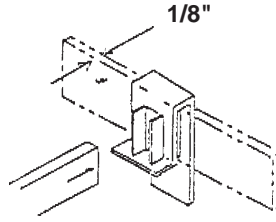

**MOUNTS ON 1/8" RAIL**

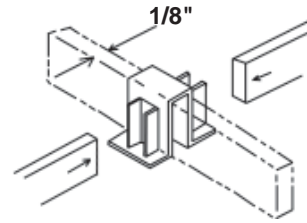

**DOUBLE SIDED FOR 1/8" RAIL**

ORDER #	MANUF. #	X=THICKNESS	COLOR	SPECIAL NOTES	BOX
<b>807-0153</b>	KHFB-500-ZC	1/2"	Zinc		500
<b>807-0161</b>	KHFB-500-BL	1/2"	Black		500
<b>807-0120</b>	SCL5087H1HT	1/2"	Zinc	For round or rectangular rail	250



## TOP MOUNT

ORDER #	MANUF. #	X=THICKNESS	COLOR	SPECIAL NOTES	BOX
<b>807-0195</b>	KHFB-TM-ZC	1/2"	Zinc	Min. thickness 1/2	500
<b>807-0203</b>	KHFB-TM-BL	1/2"	Black	Min. thickness 1/2	500

## FLUSH MOUNT

ORDER #	MANUF. #	X=THICKNESS	COLOR	SPECIAL NOTES	BOX
<b>807-0179</b>	KHFB-FM-ZC	N/A	Zinc		500
<b>807-0187</b>	KHFB-FM-BL	N/A	Black		500

## 1/8" RAIL CLIPS

ORDER #	MANUF. #	X=THICKNESS	COLOR	SPECIAL NOTES	BOX
<b>807-0211</b>	KHFB-1/8-ZC	1/8"	Zinc	Single sided	500
<b>807-0229</b>	KHFB-1/8-BL	1/8"	Black	Single sided	500
<b>807-0138</b>	KHFB-DS1/8ZC	1/8"	Zinc	Double sided	500
<b>807-0146</b>	KHFB-DS1/8BL	1/8"	Black	Double sided	500

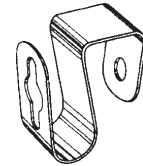

**SCL5087HIHT 1/2"**

## Dividers for Phonograph Records

- Eliminates the trouble and cost of wood partitions for records and other vertical storage
- Insert into predrilled holes in base 3/16" by 1/2" deep
- Square shape: 6-1/2" H x 5-1/2" W

300/Box

ORDER #	MANUF. #	FINISH
<b>927-0331</b>	X-51B N	Polished Chrome

